

LC-R0612P*1

For main and standby power supplies.
Expected trickle design life: 6 – 9 years at 20°C according to Eurobat.

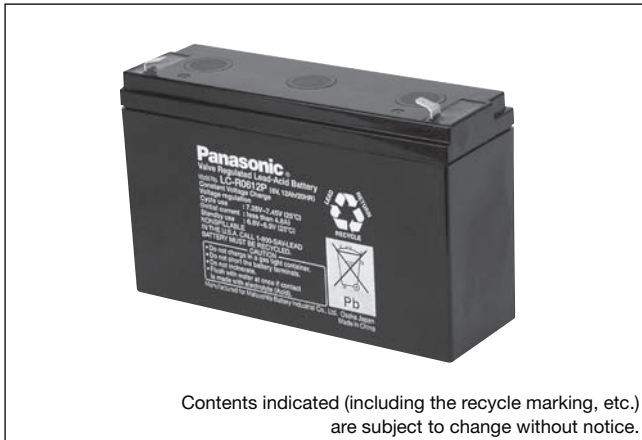

Dimensions (mm)

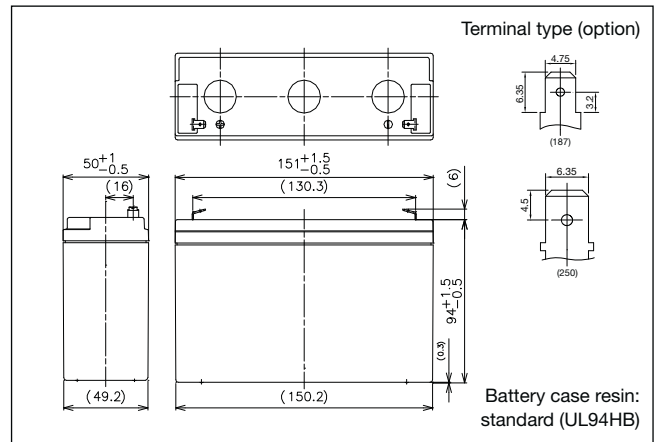

Specifications

Nominal voltage	6V	
Nominal capacity (20 hour rate)	12Ah	
Dimensions	Length	151mm
	Width	50mm
	Height	94mm
	Total Height	100mm
Approx. mass	2.00kg	
Terminal	Faston 187 or Faston 250 with hole	

Duration of discharge vs Discharge current

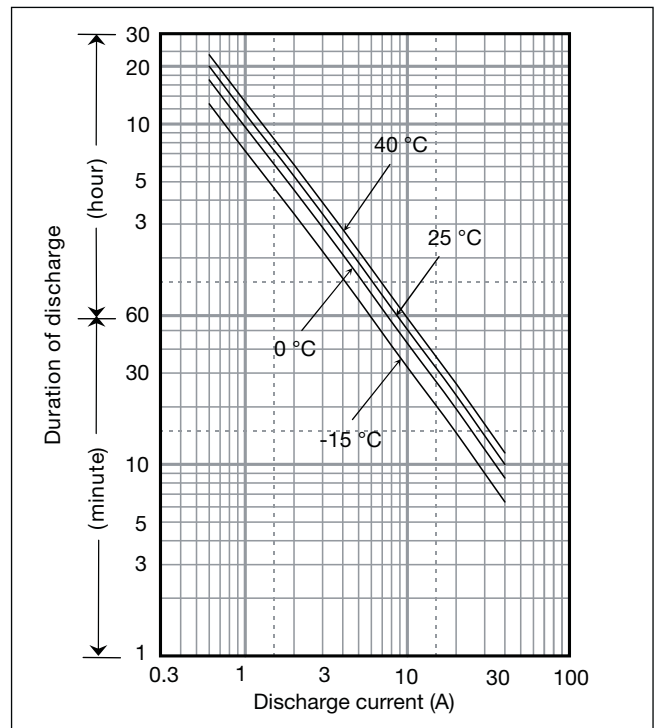

Characteristics

Capacity (25°C)	20 hour rate	12.0Ah
	10 hour rate	11.3Ah
	5 hour rate	10.4Ah
	1 hour rate	8.1Ah
Internal resistance	Fully charged battery (25°C)	15mΩ
Temperature dependency of capacity (20 hour rate)	40°C	102%
	25°C	100%
	0°C	85%
	-15°C	65%
Self discharge (25°C)	After 3 months	91%
	After 6 months	82%
	After 12 months	64%

Watt Table

(Wattage/Battery)

Cut-off V	3min	5min	10min	15min	20min	30min	45min	1h	1.5h	2h	3h	4h	5h	6h	10h	20h	24h
4.8V	340	279	192	149	124	91.3	68.7	52.4	35.1	27.2	19.0	14.4	12.0	10.9	6.66	3.61	3.01
4.95V	325	269	186	144	121	88.3	67.5	51.8	35.0	27.1	18.9	14.4	12.0	10.9	6.66	3.61	3.01
5.1V	304	253	181	141	118	88.3	66.9	51.2	34.5	26.9	18.7	14.4	12.0	10.8	6.60	3.61	3.01
5.25V	278	237	171	136	115	86.0	66.3	50.1	34.2	26.6	18.4	14.3	12.0	10.8	6.60	3.60	3.00
5.4V	247	217	161	131	113	83.1	61.6	48.9	33.1	26.0	18.1	14.2	11.9	10.7	6.54	3.59	2.99

Ampere Table

(Ampere/Battery)

Cut-off V	3min	5min	10min	15min	20min	30min	45min	1h	1.5h	2h	3h	4h	5h	6h	10h	20h	24h
4.8V	61.1	50.1	34.3	25.9	21.3	15.6	11.7	8.90	5.95	4.60	3.20	2.41	2.01	1.81	1.11	0.602	0.502
4.95V	58.4	48.2	33.3	25.0	20.8	15.1	11.5	8.80	5.92	4.58	3.18	2.41	2.01	1.81	1.11	0.602	0.502
5.1V	54.6	45.4	32.4	24.5	20.3	15.1	11.4	8.70	5.85	4.55	3.15	2.41	2.00	1.80	1.10	0.601	0.501
5.25V	50.0	42.6	30.6	23.6	19.9	14.7	11.3	8.50	5.80	4.50	3.10	2.40	2.00	1.80	1.10	0.600	0.500
5.4V	44.5	38.9	28.7	22.7	19.4	14.2	10.5	8.30	5.60	4.40	3.05	2.38	1.99	1.79	1.09	0.598	0.498

*1 This battery is also available with a flame retardant battery case resin (UL94 V-0).

Charging Method

Cycle use	Control voltage: 7.25 - 7.45V; Initial current: 4.8A or smaller
Trickle use	Control voltage: 6.8 - 6.9V; Initial current: 1.8A or smaller

Cut off voltage

Discharge current	0.6A - 2.4A	2.4A - 6A	6A - 12A	12A - 24A	24A - 36A
Cut off voltage (V)	5.25	5.1	4.95	5.65	4.35

Influence of Temperature on Trickle life

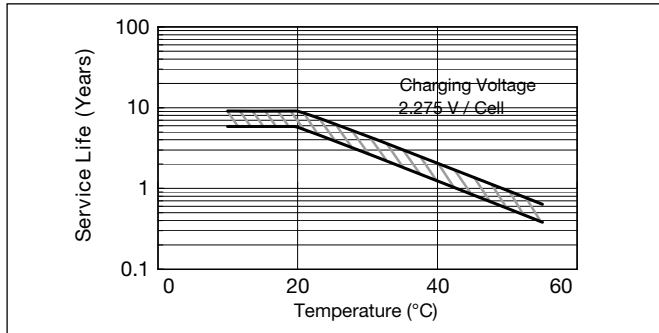

Cycle life vs Depth of discharge

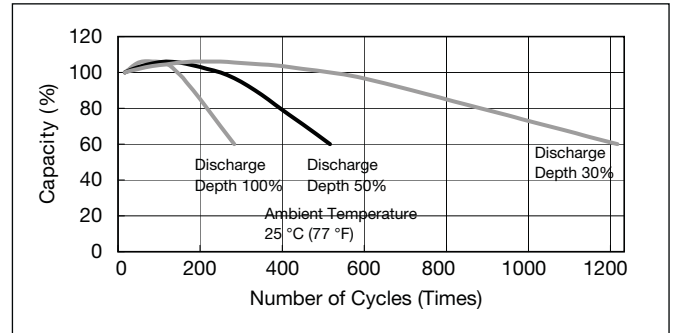

Residual capacity vs storage period

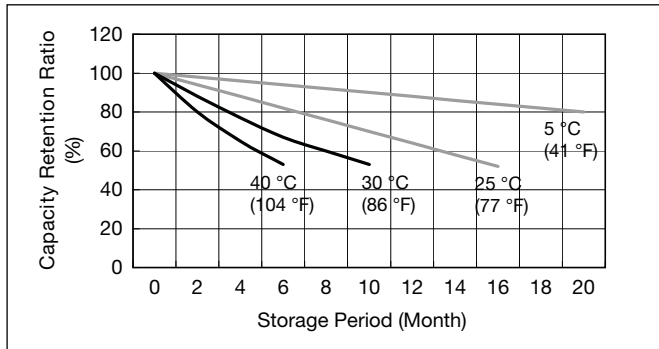

Discharge capacity by temperature and by discharge current

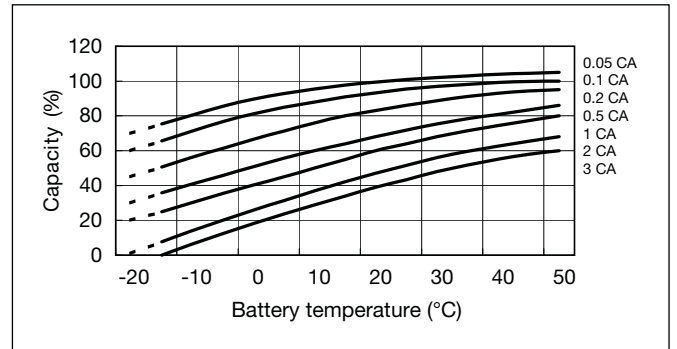

Constant-voltage and constant-current charge characteristics for Trickle use

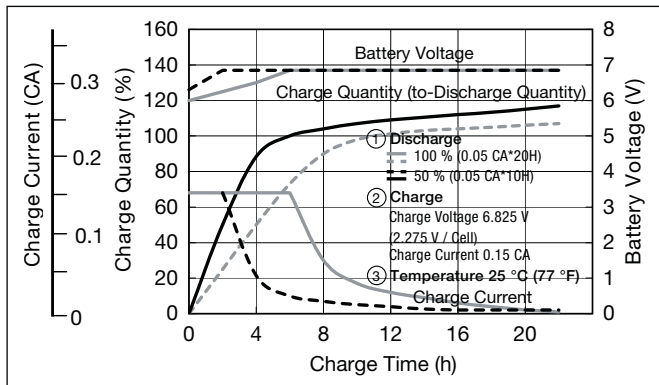

Constant-voltage and constant-current charge characteristics for Cycle use

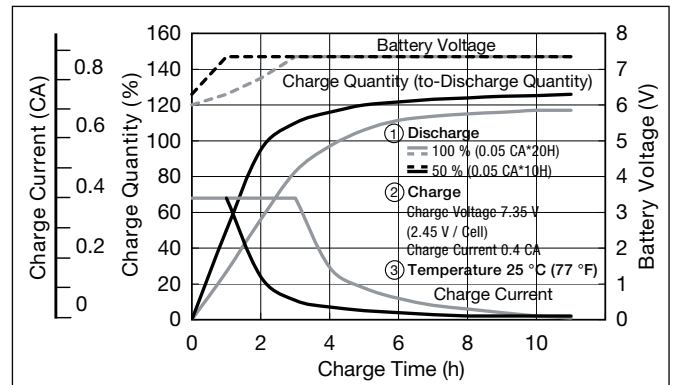

Discharge characteristics

