

**ENERGIZER L91**  
Ultimate Lithium

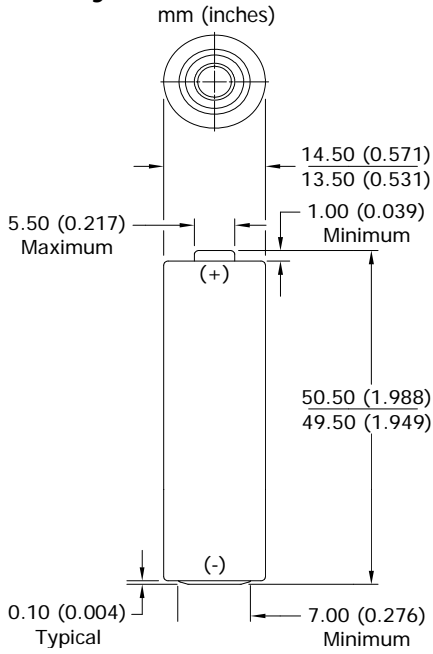

**AA**

**Industry Standard Dimensions**



This battery has Underwriters Laboratories component recognition (MH29980)

**Specifications**

<b>Classification:</b>	"Cylindrical Lithium"
<b>Chemical System:</b>	Lithium/Iron Disulfide (Li/FeS <sub>2</sub> )
<b>Designation:</b>	ANSI 15-LF, IEC-FR6
<b>Nominal Voltage:</b>	1.5 Volts
<b>Storage Temp:</b>	-40°C to 60°C (-40°F to 140°F)
<b>Operating Temp:</b>	-40°C to 60°C (-40°F to 140°F)
<b>Typical Weight:</b>	14.5 grams (0.5 oz.)
<b>Typical Volume:</b>	8.0 cubic centimeters (0.5 cubic inch)
<b>Max Discharge:</b>	2.0 Amps Continuous
(single battery only)	3.0 Amps Pulse (2 sec on / 8 sec off)
<b>Max Rev Current:</b>	2 uA
<b>Typical Li Content:</b>	0.98 grams (0.03 oz.)
<b>Typical IR:</b>	90 to 150 milliohms*
<b>Shelf Life:</b>	15 years at 21°C (90% of rated capacity)
<b>Transportation:</b>	For complete details, please reference:
Global (except US):	Special Provision A45 of the International Air Transport Association Dangerous Goods Regulations
United States:	49 CFR 173.185

\* For additional information, please reference the [IR technical white paper](#).

**Milliamp-Hours Capacity**

Constant Current Discharge to 0.9 Volts at 21°C

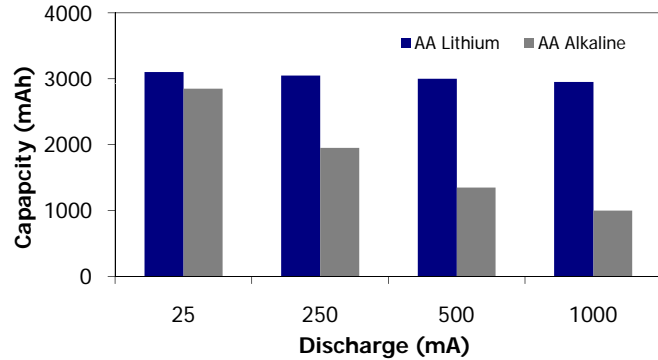

**Milliwatt-Hours Capacity at Cold/Room Temperature**

Constant Power Discharge to 1.0 Volts at 0°C and 21°C

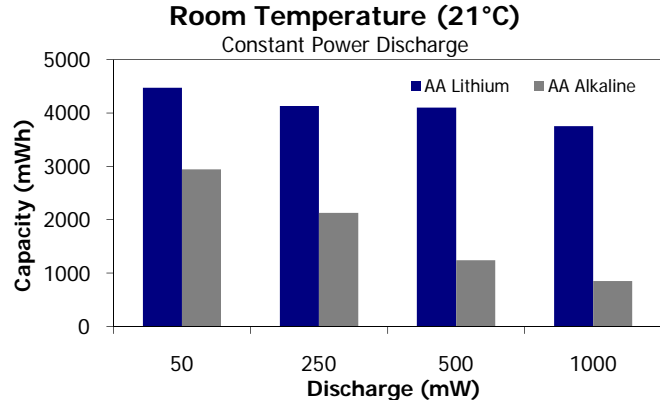
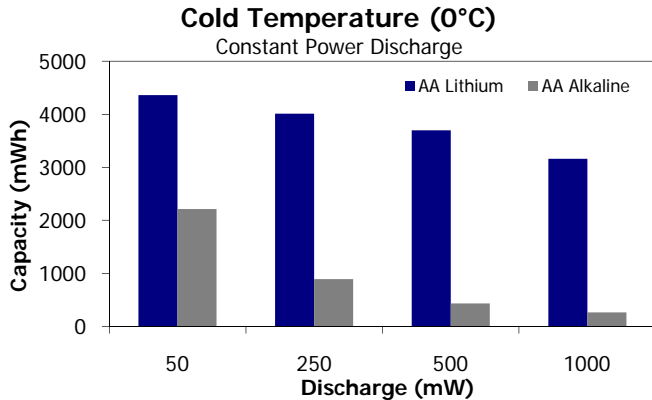

**Important Notice**

This datasheet contains typical information specific to products manufactured at the time of its publication.  
©Energizer Holdings, Inc. - Contents herein do not constitute a warranty.

# ENERGIZER L91

**AA**

## Typical Discharge Curve Characteristics

Constant Current Discharge at 21°C (low and high drains)

**Low Drain Performance**  
50mA Continuous (21°C)

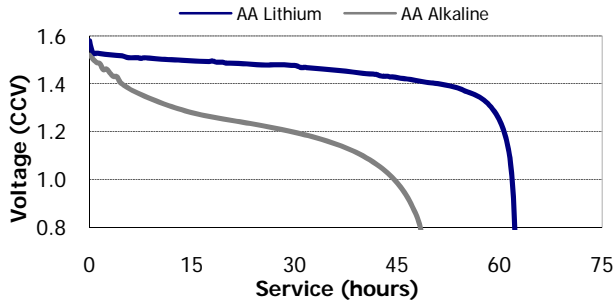

**High Drain Performance**  
1000mA Continuous (21°C)

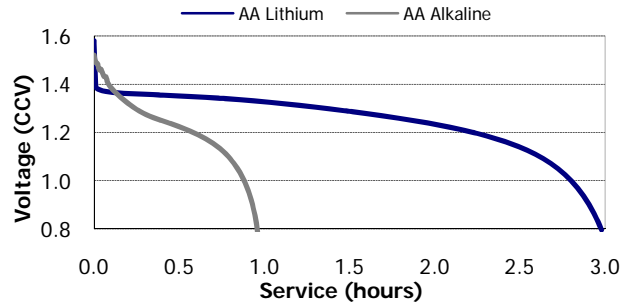

## Constant Power Performance

Typical Characteristics to 1.0 Volts (21°C)

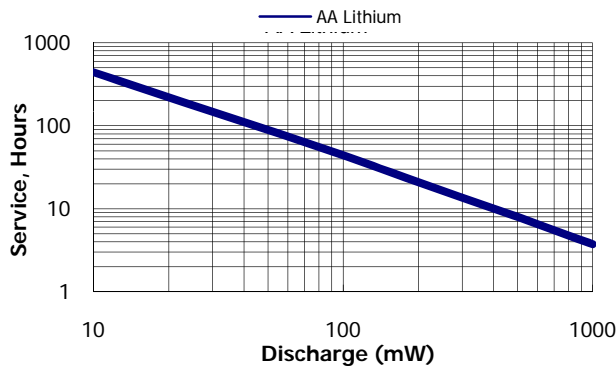

## Constant Current Performance

Typical Characteristics to 1.0 Volts (21°C)

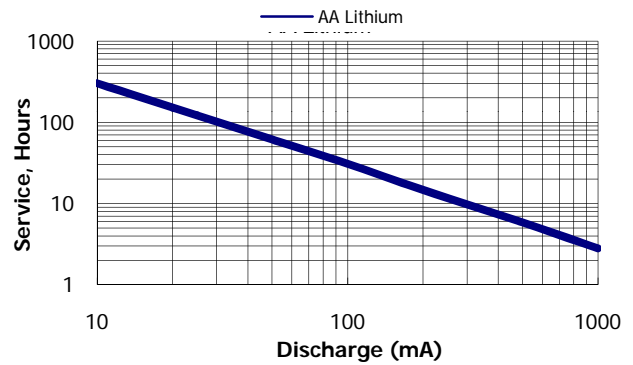

## Application Tests (21°C)

REMOTE: 24 ohm 15 sec/min 8 hrs/day  
RADIO: 43 ohm 4 hrs/day

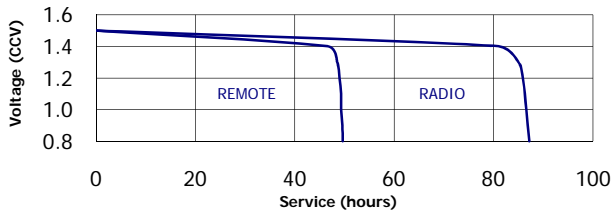

## Application Tests (21°C)

CD/GAMES: 250 mA 1 hr/day  
DIGITAL AUDIO: 100 mA 1 hr/day

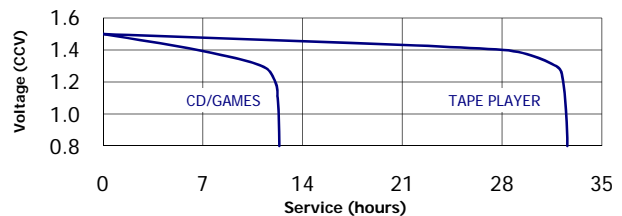

## Application Tests (21°C)

TOOTHBRUSH: 500 mA 1/13 min 24 hrs/day  
PORTABLE LIGHTING: 3.3 ohm LIF  
TOY: 3.9 ohm 1 hr/day

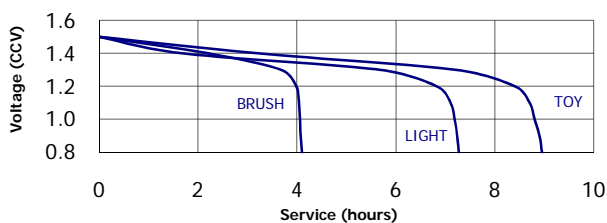

## Industry Standard Tests (21°C)

PHOTOFLASH: 1K mA 10 sec/min 1 hr/day  
DIGITAL CAMERA: 1.5/.65K mW 2.1/27.9s 10X

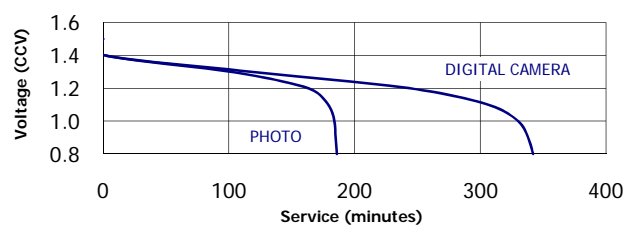

### Important Notice

This datasheet contains typical information specific to products manufactured at the time of its publication.  
©Energizer Holdings, Inc. - Contents herein do not constitute a warranty.