

6FM80D-X 12V 80Ah(10hr)

The rechargeable batteries are lead-lead dioxide systems. The dilute sulfuric acid electrolyte is absorbed by separators and plates and thus immobilized. Should the battery be accidentally overcharged producing hydrogen and oxygen, special one-way valves allow the gases to escape thus avoiding excessive pressure build-up. Otherwise, the battery is completely sealed and is, therefore, maintenance-free, leak proof and usable in any position.



Battery Construction

Component	Positive plate	Negative plate	Container	Cover	Safety valve	Terminal	Separator	Electrolyte
Raw material	Lead dioxide	Lead	ABS	ABS	Rubber	Copper	Fiberglass	Sulfuric acid

General Features

- Absorbent Glass Mat (AGM) technology for efficient gas recombination of up to 99% and freedom from electrolyte maintenance or water adding.
- Not restricted for air transport-complies with IATA/ICAO Special Provision A67.
- UL-recognized component.
- Can be mounted in any orientation.
- Computer designed lead, calcium tin alloy grid for high power density.
- Long service life, float or cyclic applications.
- Maintenance-free operation.
- Low self discharge.

Dimensions and Weight

Length(mm / inch).....350 / 13.78
 Width(mm / inch).....167 / 6.57
 Height(mm / inch).....179 / 7.05
 Total Height(mm / inch).....179 / 7.05
 Approx. Weight(Kg / lbs).....24 / 52.9

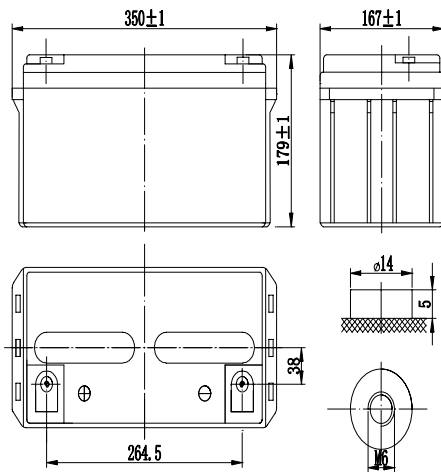

Performance Characteristics

Nominal Voltage 12V
 Number of cell 6
 Design Life 10 years
 Nominal Capacity 77°F(25°C)
 10 hour rate (8.00A, 10.8V) 80.0Ah
 5 hour rate (13.2A, 10.5V) 66Ah
 1 hour rate (47.9A, 9.6V) 47.9Ah
 Internal Resistance
 Fully Charged battery 77°F(25°C) 5.5mOhms
 Self-Discharge
 3% of capacity declined per month at 20°C(average)
 Operating Temperature Range
 Discharge -20~60°C
 Charge -10~60°C
 Storage -20~60°C
 Max. Discharge Current 77°F(25°C) 750A(5s)
 Short Circuit Current 1900A
 Charge Methods: Constant Voltage Charge 77°F(25°C)
 Cycle use 14.4-14.7V
 Maximum charging current 24A
 Temperature compensation -30mV/°C
 Standby use 13.6-13.8V
 Temperature compensation -20mV/°C

Discharge Constant Current (Amperes at 77°F25°C)

End Point Volts/cell	5min	10min	15min	30min	1h	3h	5h	10h	20h	100h
1.60V	254	193	147	87.9	50.7	22.1	14.6	8.20	4.29	0.97
1.65V	239	183	141	85.2	49.8	21.7	14.4	8.16	4.29	0.96
1.70V	223	172	135	82.4	49.1	21.3	14.2	8.11	4.29	0.96
1.75V	210	163	129	79.7	48.4	20.8	14.0	8.05	4.23	0.95
1.80V	195	153	121	77.0	47.5	20.3	13.8	8.00	4.17	0.95

Discharge Constant Power (Watts at 77°F25°C)

End Point Volts/cell	5min	10min	15min	30min	45min	1h	2h	3h	5h	100h
1.60V	444	331	281	160	125	103	57.8	42.3	28.9	1.95
1.65V	422	320	267	158	123	100	56.6	39.3	28.5	1.92
1.70V	400	307	253	154	120	98.5	55.7	38.6	28.0	1.93
1.75V	378	294	238	153	117	96.6	54.6	37.9	27.4	1.94
1.80V	357	283	223	150	114	94.7	53.7	37.1	26.8	1.95

(Note)The above characteristics data are average values obtained within three charge/discharge cycles not the minimum values.

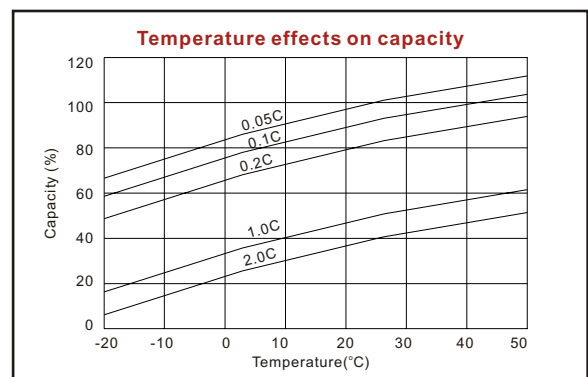
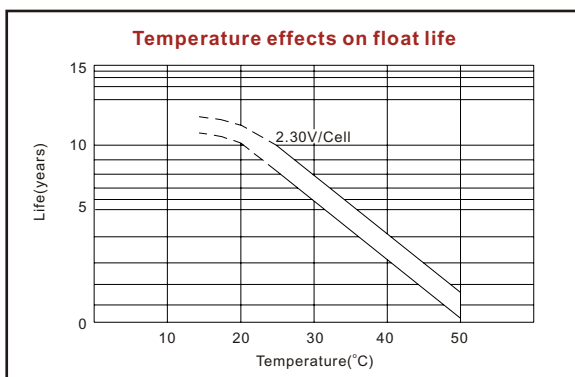
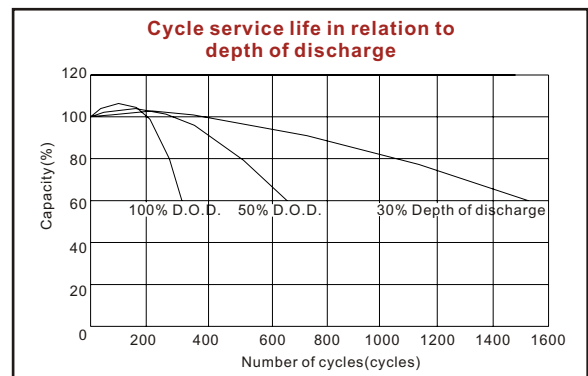
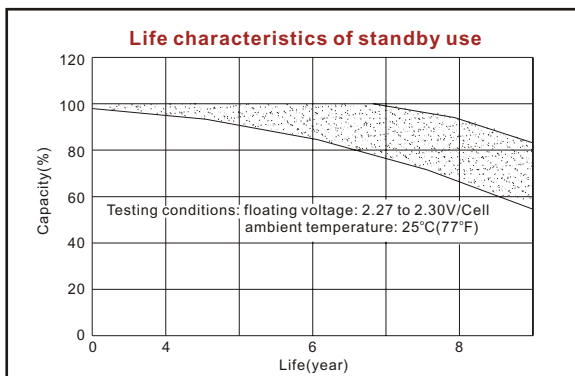
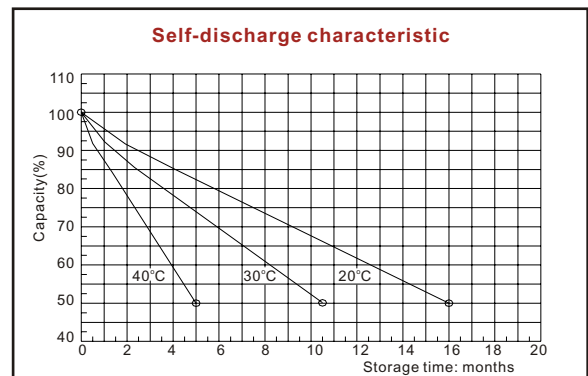
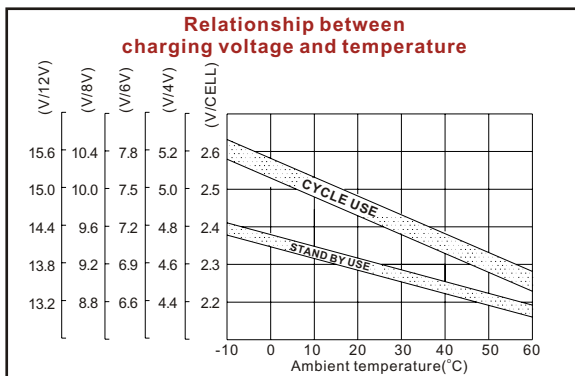
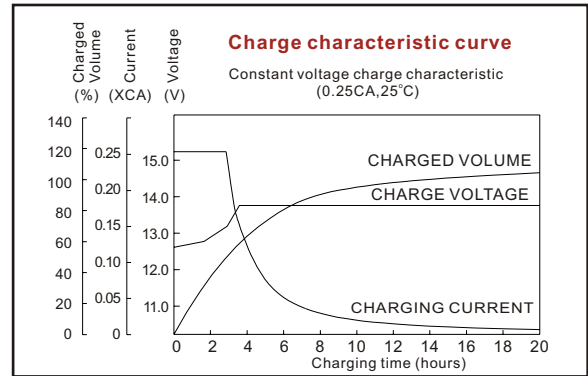
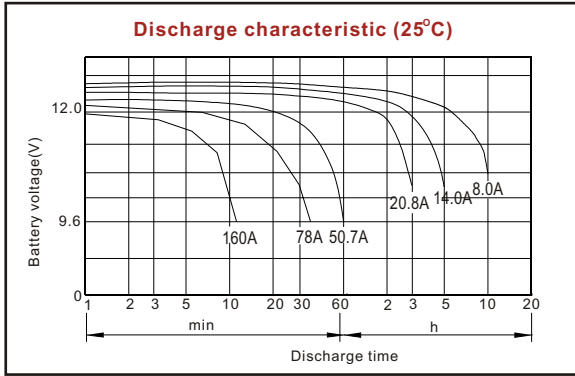

ISO9001:2000

MH25860

G4M19906-9202-E-16

www.vision-batt.com

Shenzhen Center Power Tech. Co., Ltd.
 Center Power Industrial Park, Tongfu Industrial District Dapeng Town, 518120 Shenzhen, China
 Tel: (+86-755) 8431 8088 Fax: (+86-755) 84318038 E-mail: sales@vision-batt.com