



VISION Rechargeable Products  
Sealed Lead Acid Battery

[www.vision-batt.com](http://www.vision-batt.com)

## FM Series

The rechargeable batteries are lead-lead dioxide systems. The dilute sulfuric acid electrolyte is absorbed by separators and plates and thus immobilized. Should the battery be accidentally overcharged producing hydrogen and oxygen, special one-way valves allow the gases to escape thus avoiding excessive pressure build-up. Otherwise, the battery is completely sealed and is, therefore, maintenance-free, leak proof and usable in any position.

Shenzhen Center Power Tech. Co., Ltd

## 6FM7.2 12V 7.2Ah

### GENERAL FEATURES

- Absorbent Glass Mat (AGM) technology for efficient gas recombination of up to 99% and freedom from electrolyte maintenance or water adding.
- Not restricted for air transport-complies with IATA/ICAO Special Provision A67.
- UL-recognized component.
- Can be mounted in any orientation.
- Computer designed lead, calcium tin alloy grid for deep cycle discharge.
- Long service life for cyclic applications.
- Maintenance-free operation.
- Low self discharge.
- Design life 10 years

### Product

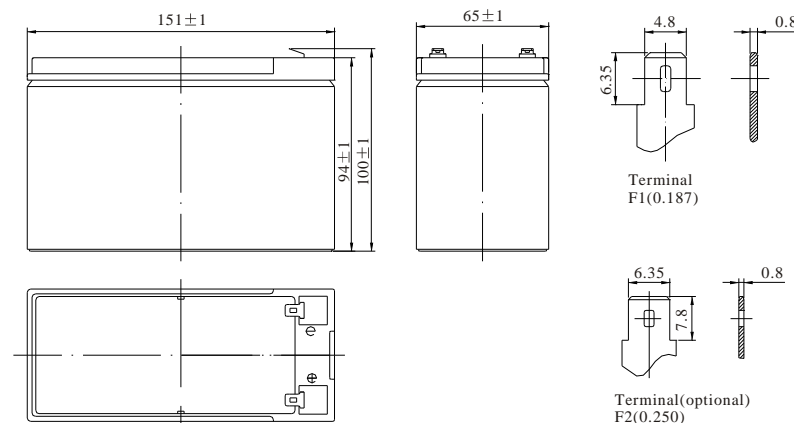

### TECHNOLOGY PARAMETER

Nominal Voltage	12V			
Number of cell	6			
Capacity(25°C)	20hR(0.39A, 10.8V)	10hR(0.72A, 10.8V)	5hR(1.16A, 10.5V)	1hR4.8A, 10.5V)
	7.8Ah	7.2Ah	5.8Ah	4.8Ah
Dimensions	Length	Width	Height	Total Height
	151±1mm	65±1mm	94±1mm	100±1mm
Approx. Weight	2.5kg (5.51lbs)			
Internal resistance	Full charged at 25°C: 22mOhms			
Self discharge	3% of capacity declined per month at 20°C (average)			
Operating temperature range	Discharge	Charge	Storage	
	-20~60°C	-10~60°C	-20~60°C	
Max. Discharge current(25°C)	108A(5s)			
Short circuit current	360A			

### CONSTRUCTION

Component	Positive plate	Negative plate	Container	Cover	Safety valve	Terminal	Separator	Electrolyte
Raw material	Lead dioxide	Lead	ABS	ABS	Rubber	Copper	Fiberglass	Sulfuric acid

# 6FM7.2 12V 7.2Ah

## Discharge Data

Constant Current Discharge Ratings-amperes at 25°C ( 77°F )

End Point Volts/Cell	5min	10min	15min	30min	1h	3h	5h	10h	20h
1.60V		18.8	15.3	8.50	4.80	1.88	1.29	0.80	0.43
1.65V		17.9	14.6	8.15	4.63	1.82	1.25	0.78	0.42
1.70V		17.0	13.9	7.86	4.44	1.76	1.20	0.76	0.41
1.75V		16.0	13.2	7.56	4.25	1.69	1.16	0.74	0.40
1.80V		15.1	12.5	7.18	4.04	1.64	1.12	0.72	0.39

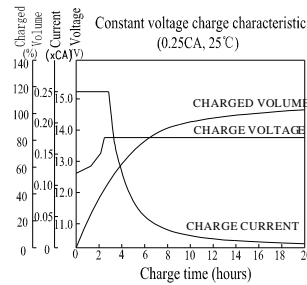

**CHARGE METHODS:** Constant voltage charging at 25°C  
 Standby use: No charge current limit is required  
 Charge voltage: 13.6-13.8Volts  
 Cyclic use: Maximum charge current: 30% of rated capacity  
 Charge voltage: 14.4-14.7volts  
 Temperature compensation:  
 Standby use: -20mV/°C; Cyclic use: -30mV/°C.

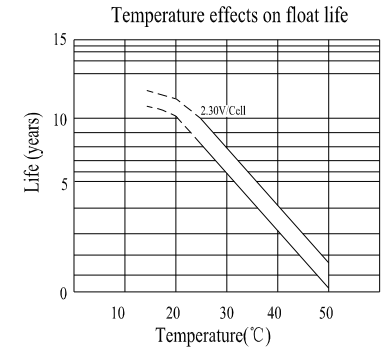

Constant Power Discharge Ratings-watts per cell at 25°C ( 77°F )

End Point Volts/Cell	5min	10min	15min	30min	45min	1h	2h	3h	5h
1.60V		35.8	28.1	15.5	11.8	9.30	5.13	3.68	2.38
1.65V		34.0	27.0	14.9	11.3	8.90	5.02	3.59	2.34
1.70V		32.2	25.9	14.3	10.8	8.53	4.89	3.49	2.30
1.75V		30.4	24.8	13.7	10.4	8.28	4.73	3.38	2.25
1.80V		28.6	23.8	13.2	10.0	7.90	4.58	3.27	2.19

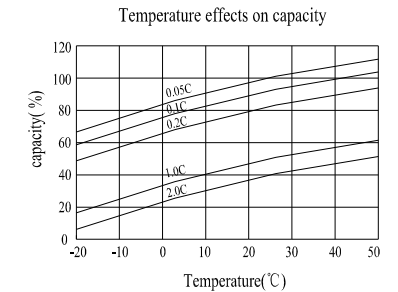
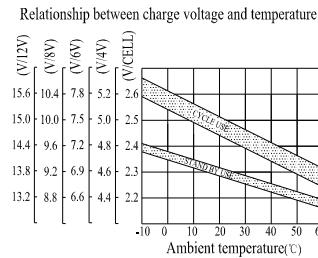
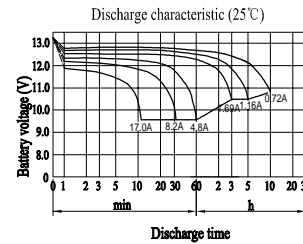

(Note)The above characteristics data are average values obtained within three charge/discharge cycles not the minimum values.

Life characteristics of standby use

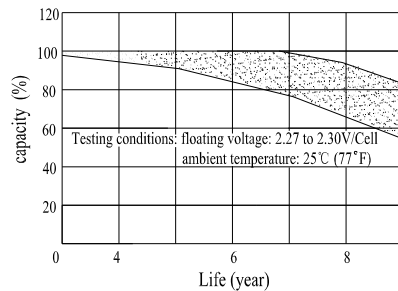

Cycle service life in relation to depth of discharge

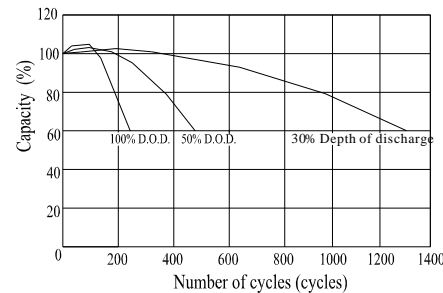

Relationship of OCV and state of charge (25°C)

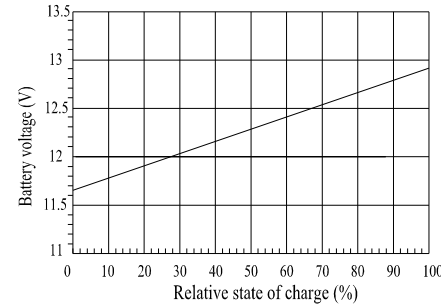

Self-discharge characteristic

